

MECHAN CONTROLS



Installation Guide : SCU-1 & HE Safety Switches

Keep this guide for future reference

This information is designed to help suitably qualified personnel install and operate Mechan Safety equipment. Before using this product, read this guide thoroughly along with any relevant European and/or National standards e.g. Machinery Directive 2006/42/EC and it's amendments, Provision and Use of Work Equipment Regulations.

Further information can be obtained from Mechan Controls

Description

Mechan HE safety switches are magnetically coded, solid state non-contact safety switches for use in machine guarding applications.

Non-contact operation makes the HE switches easy to install and tolerant to misalignment. The solid state design is even more tolerant to shock and vibration, and provides single point switching which makes for a simpler and more reliable machine guard interlock.

The additional security of the coded magnetic operation along with fully sealed IP67 rating make these switches ideal for use in wet or dusty and harsh environments.

The HE safety switches have been designed to connect to the SCU-1 Safety Control Unit. When installed correctly, up to 30 switches can be installed in series.

Operation

The HE safety switch has up to 2 x N/O + 1 N/C bi-directional solid state outputs along with built in LED(s) for indication. When installed on a machine guard, power is applied, and the switch and actuator are within the specified operating range, the N/O Outputs will be closed, the N/C Output will be open. When the actuator moves out of the operating range, the N/O Outputs will open, the N/C Output will close. (See page 3 for LED Indication.)

The HE safety switch and actuator have a 7mm switching distance and can approach each other from most angles. When the switch is closed the targets on the printed face of the switch must be aligned.

To avoid physical damage, do not use the switch and actuator as a stop, leave a 1-2 mm gap for best operation and tolerance to machine guard vibration.

Applications

Interlocked guards where additional security required.
 Door locking is not required.
 Harsh environments where vibration, water or dust are problems.
 Food and Beverage packing/filling systems
 Dairy Pharmaceutical Paper Industry
 Can Forming and Filling, (Aluminium, Steel, Plastic)
 Semi conductor Manufacture/Assembly.

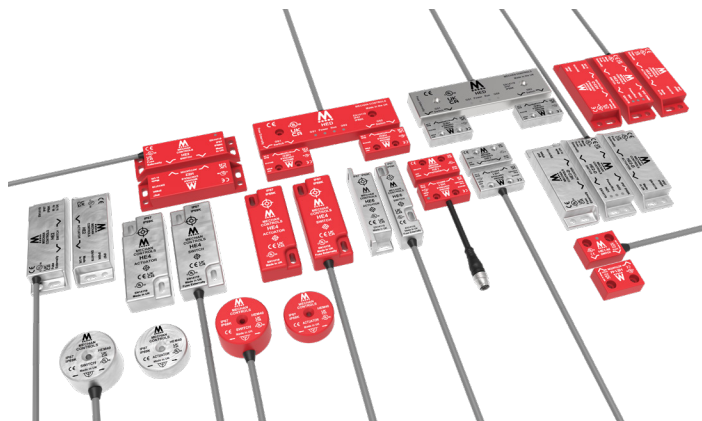

CAT 4 SIL 3 PL_e



APPROVALS	
CE	Complies with all relevant sections of the CE marking directive
UKCA	Complies with all relevant sections of the UKCA marking directive
TUV	CAT 4 SIL 3 PL _e
INTERNATIONAL DIRECTIVES	
Machinery Directive 2006/42/EC	
Low Voltage Directive 2014/35/EU	
RoHS Directive 2011/65/EU	
Electromagnetic Compatibility Directive 2014/30/EU	
INTERNATIONAL STANDARDS	
EN ISO 13849-1	Safety of Machinery Safety related parts of control systems
EN ISO 62061	Safety of Machinery - Functional safety of safety related electrical, electronic and programmable electronic control systems
EN 60204	Safety of Machinery Electrical equipment for machines
EN 60947-5-1	Low voltage switch gear and control gear
EN 14119	Interlocking devices associated with guards
EN 60947-5-3	Safety of Machinery Specification for low voltage switchgear and control gear

SAFETY CONTROL UNIT - SCU1

Mounting on 35mm DIN Rail

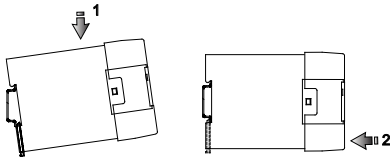

The control modules are designed to be mounted in an IP55 (minimum) control cabinet.

The modules clip on to standard 35 mm symmetric DIN-Rail

Removal from 35mm DIN Rail

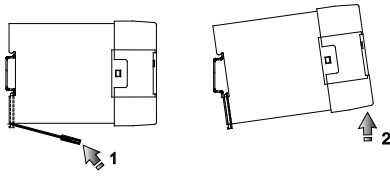

To remove the modules, gently lever out the DIN clip with a small screwdriver as shown (1).

Tilt the unit in the direction (2) and slip the unit off the DIN Rail

Indication

POWER
When power is connected, the red LED will be illuminated

OUTPUT
When K1 & K2 are illuminated green, the outputs 13/14 & 23/24 will be closed and 31/32 will open.

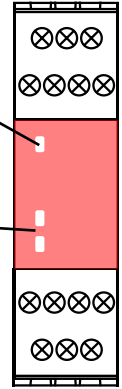

CONTROL UNIT RESET

To remove lid, use small screwdriver in the lid recess as shown and prise gently upwards.

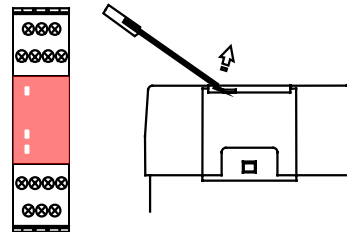

Manual Reset

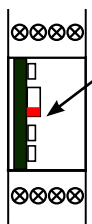

Internal switch is set to the LOWER position

Circuit X1/X2 requires a momentary N/O button to initialise reset.

Automatic Reset

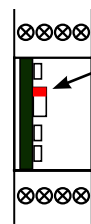

Internal switch is set to the UPPER position

Circuit X1/X2 requires a link.
NOTE: Closed contacts on K3 & K4 can still be monitored

MOUNTING SAFETY SWITCHES

HE1/2/3/4/6 & HEM40 Safety Switches

Do not use safety switches, as a stop. 1 mm separation when closed provides the best results.

Mount the switch on to the machine frame and the actuator on to the opening edge of the door.

Always try to mount the switch on non-ferrous material. (Ferrous materials may reduce the switching distance.)

Minimum separation 50mm between adjacent switches.

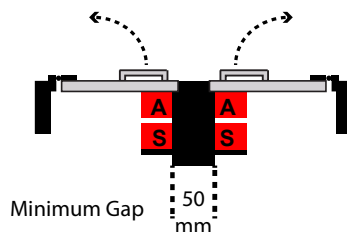

DO NOT mount on hinged side of the guard.

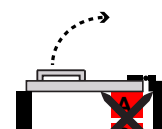

EN14119 : Hide the actuator where possible.

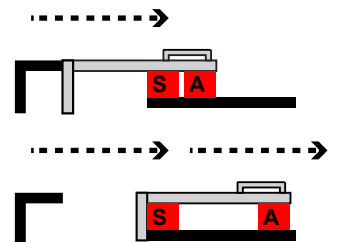

HED Safety Switches - 2 Gate operation

HED Switches are designed to monitor 2 doors with one switch and 2 actuators. Simplifying installation by reducing wiring to the control panel, and the number of brackets required for the switches.

Both gates must be closed to enable the NO contacts of the switch to close and the NC indication contact to open. Opening either gate will open the NO contacts and close the NC contact. LED indication is available on the switch to help fault diagnosis.



SAFETY SWITCHES

Indication

	HE1, HE1-M, HE2, HE3, HE4, HE6	HED			
		GS1	Power	Run	GS2
Power Off	Off	Off	Off	Off	Off
Power On Gate(s) Open	Red	Off	Red	Off	Off
Power On Gate 1 Closed	Green	Yellow	Red	Off	Off
Power On Gate 1 and 2 Closed		Yellow	Red	Green	Yellow
NOTE:	HEM-40 Does not have on switch LED Indication				

Operation

The HE safety switches have up to 2xN/O + 1xN/C solid state outputs along with built in LED(s) for indication. With power applied to the switch and actuator aligned correctly within the specified operating range, the N/O Outputs will be closed, the N/C Output will be open. When the actuator moves out of the operating range, the N/O Outputs will open, the N/C Output will close. The actuator(s) can approach the switch from any angle without false tripping. When the guard is closed the targets on the printed face of the switch and actuator must be aligned.

NOTE: The HED switch requires both actuators to be in place to operate the contacts. Removing one actuator will open the NO contacts and close the NC contact.

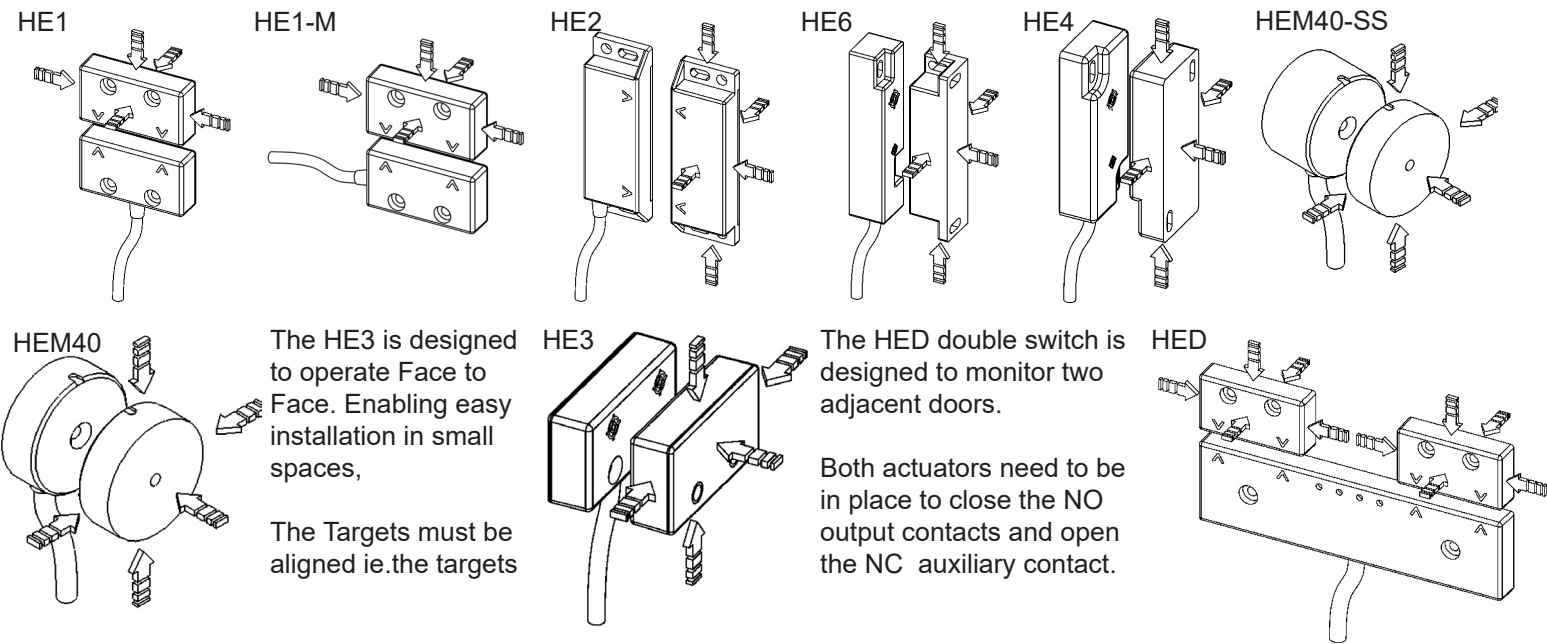

Switching Characteristics

The chart shows the switching points in millimetres.

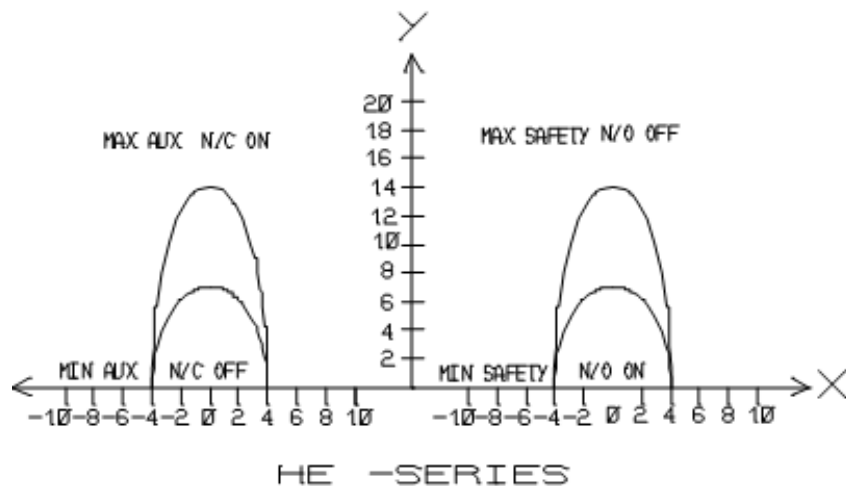

CONNECTIONS & FUSES

Pre-wired Switches

HE1 / HE1-M / HE2 / HE3 / HE4 / HE6 / HEM40
Contacts 2NO + 1NC

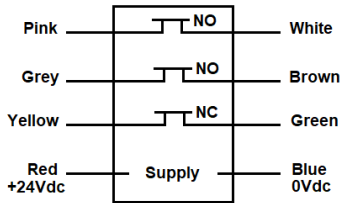

HE1 / HE2
Contacts 2NO

(Note: Yellow & Green not connected)

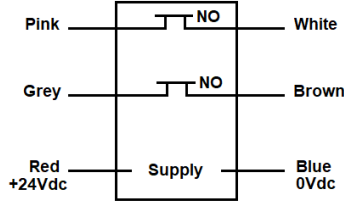

HE1 / HE2
Contacts 1NO + 1NC

(See Note 1)

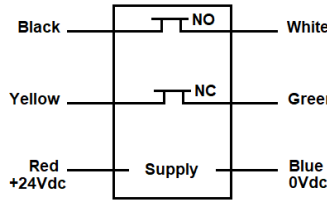

HE6-20
Contacts 2NO

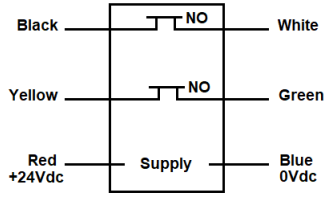

M12 Leaded Quick Disconnect

HE1
Contacts 1NO

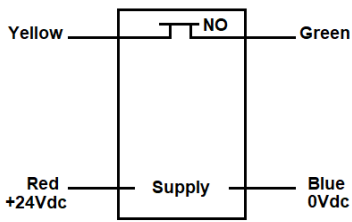

M12 Leaded Quick Disconnect (LQD)
HE1 / HE2 / HE6 & HED

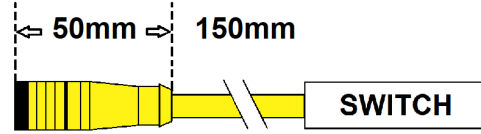

HEX21-LQD
2NO + 1NC

HE6-11-LQD
1NO + 1NC

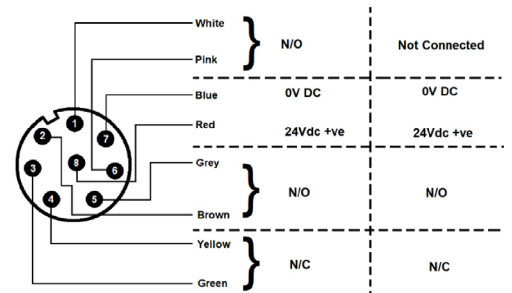

CONTACT OPERATION - The N/O contact(s) on Mechan safety switches are open when the actuator is away from the switch. When the actuator is within the specified operation distance, the N/O contact(s) will close and N/C contact will open.

NOTE 1 : THE 1 N/O + 1 N/C SWITCH WILL NOT OPERATE THE SCU1 CONTROL UNIT. THE SCU1 CONTROL UNIT REQUIRES 2 N/O INPUTS FROM THE HE1 SWITCH TO OPERATE.

CONNECTION FOR A SINGLE SWITCH (HE6-20)

Fuse A: Main fuse for overall circuit including the contactors.

400mA Fuses: Fast acting (quick Blow) to protect all switch contacts.

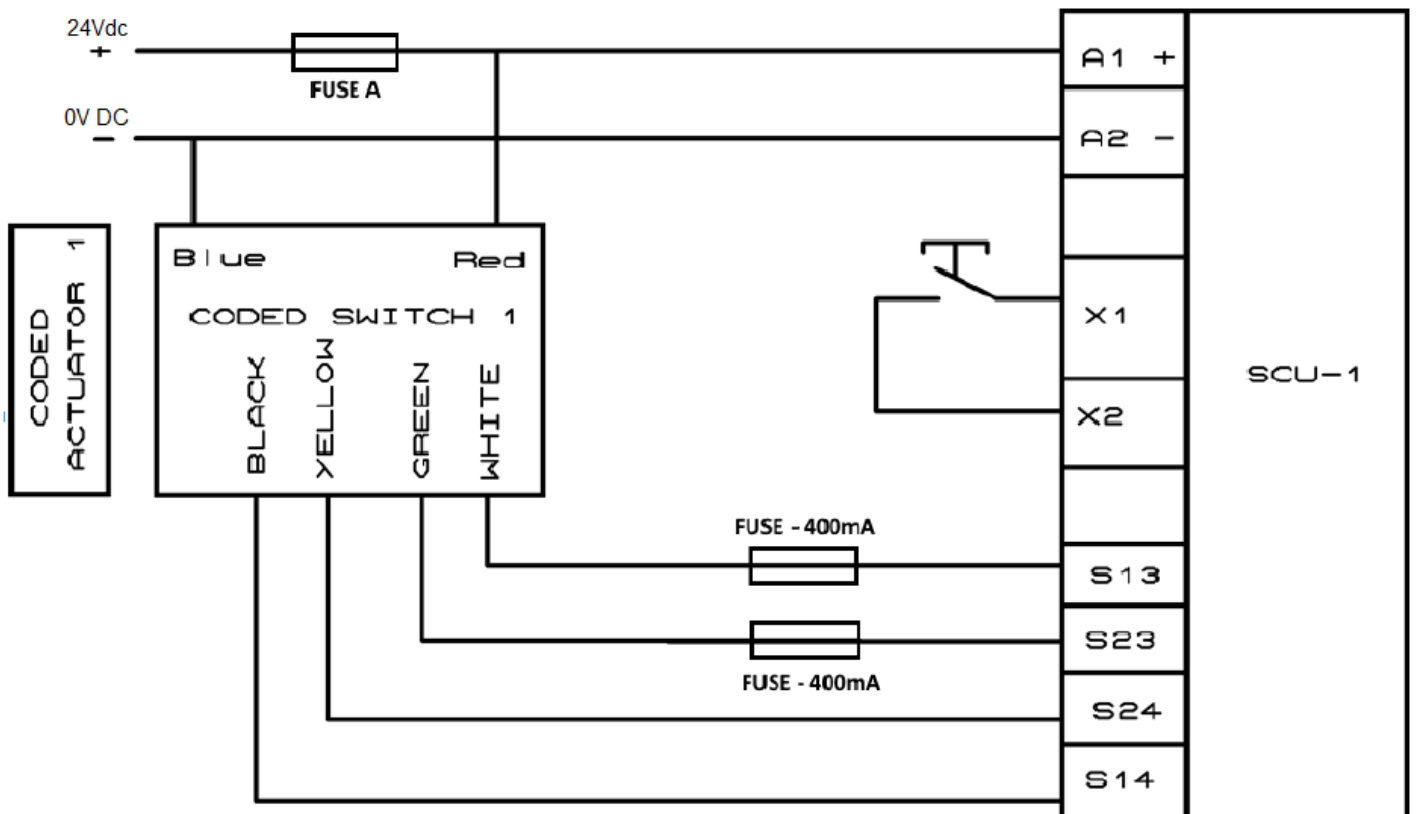

CONNECTION FOR A SINGLE SWITCH

Fuse A: Main fuse for overall circuit including the contactors.

400mA Fuses: Fast acting (quick Blow) to protect all switch contacts.

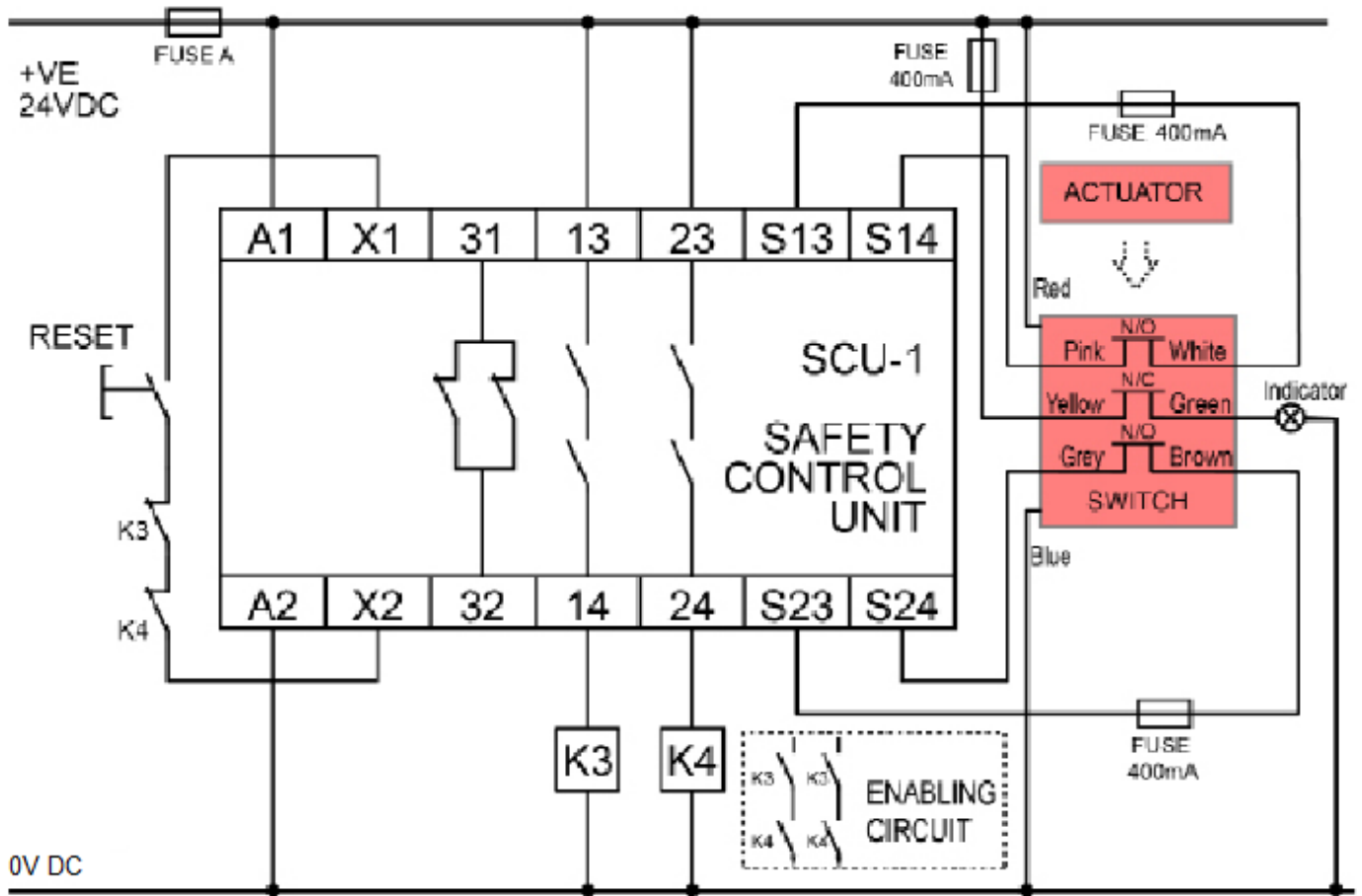

CONNECTION FOR UP TO 30 SWITCHES

Fuse A: Main fuse for overall circuit including the contactors.

400mA Fuses: Fast acting (quick Blow) to protect all switch contacts.

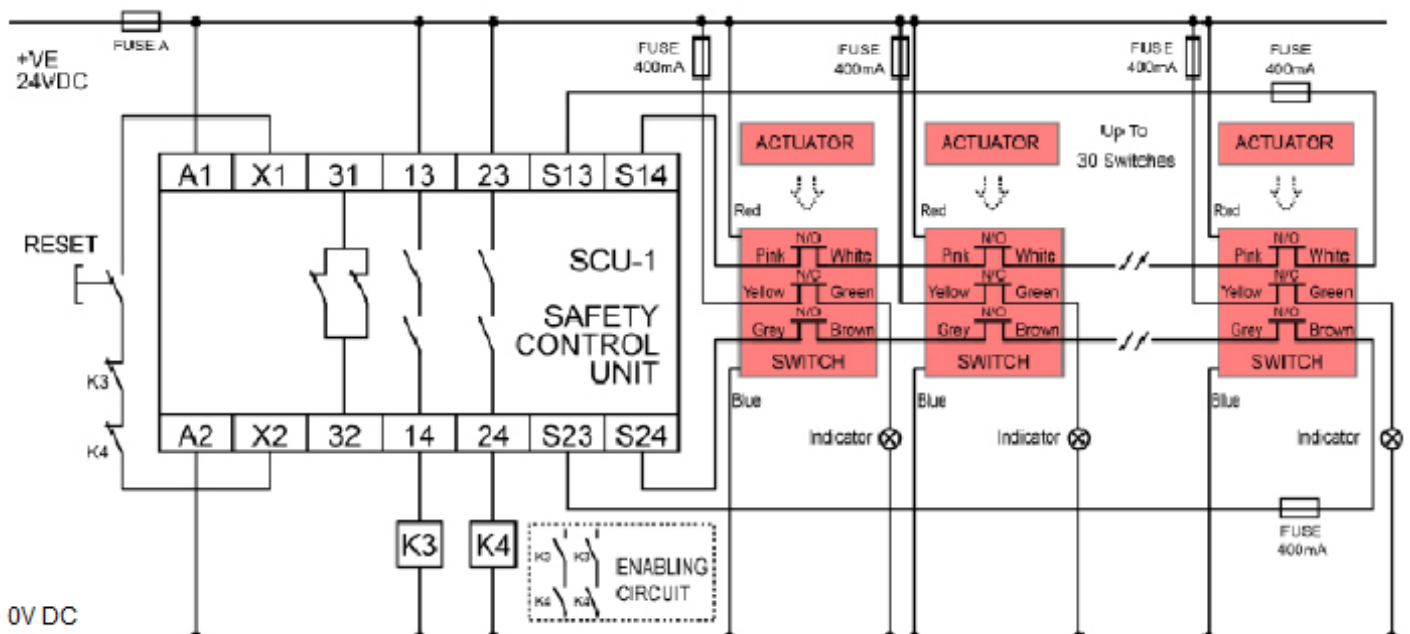

DIMENSIONS

SCU-1

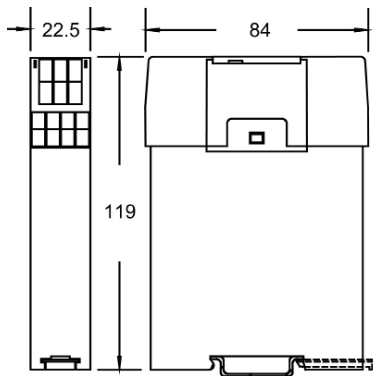

HEM40-SS

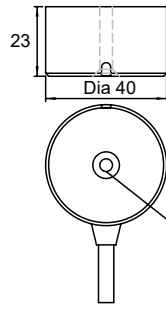

HEM40

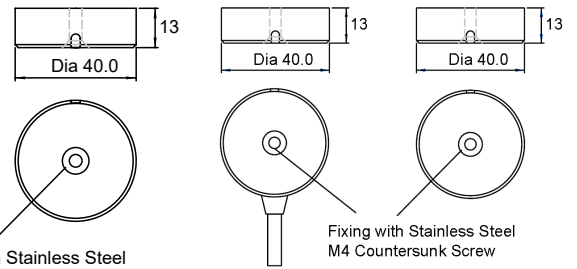

HE1 & HE1-SS

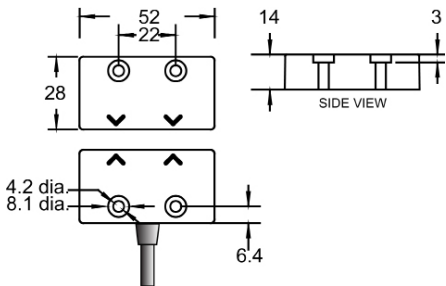

HE1-M

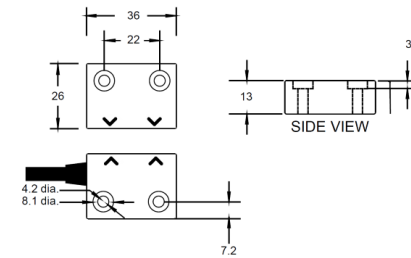

HE3 & HE3-SS

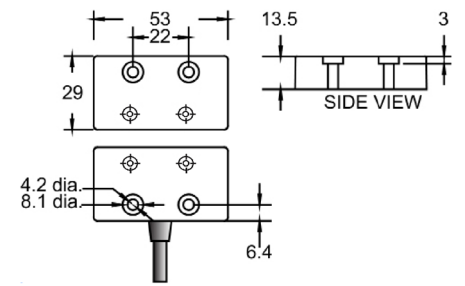

HE2 & HE2-SS

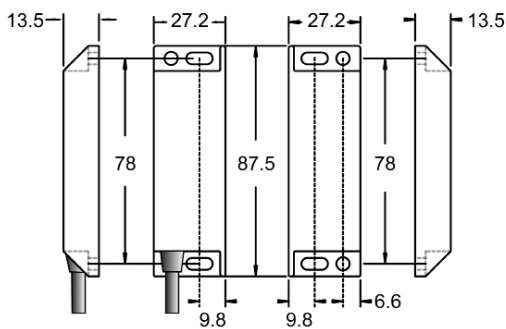

HE6

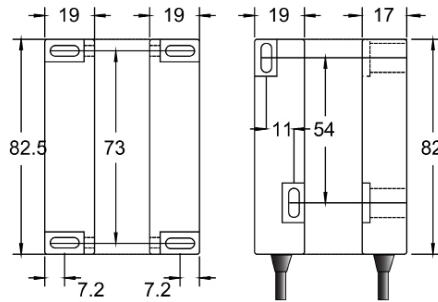

HE6-SS

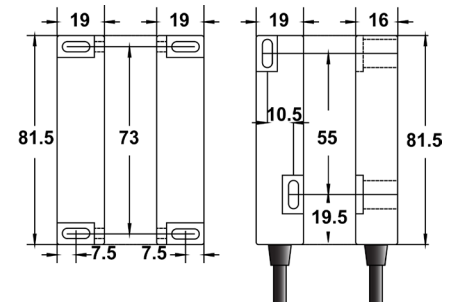

HE4

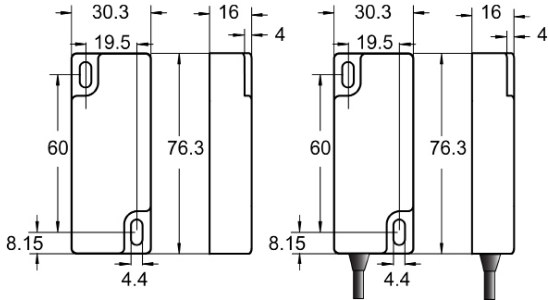

HE4-SS

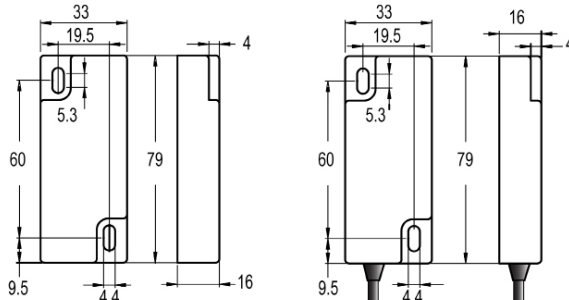

HED

NOTE

HED switch has three options for cable exit to ensure easy installation:

HE21-DC-xxC

Cable exit in centre of switch (1)

HE21-DC-xxL

Cable exit from left hand side of the switch (2)

HE21-DC-xxR

Cable exit from right hand side of the switch (3)

xx= cable length or lqd

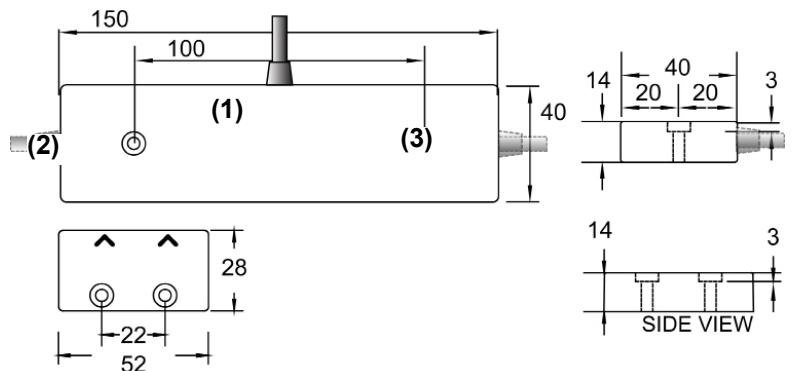

TECHNICAL SPECIFICATIONS

SAFETY SWITCHES	
Supply Voltage	24Vdc (+/-15%)
Operation	Magnetically Coded Non-contact
Contact Arrangements	2 x N/O + 1 x N/C or 2 x N/O or 1 x N/O or 1N/O + 1 N/C
Safety Contact N/O Minimum ON	7mm
Safety Contact N/O Maximum OFF	14mm
Auxillary Contact N/C Minimum OFF	7mm
Auxillary Contact N/C Maximum ON	14mm
Safety Contact Rating	DC: 24Vdc / 400mA
Auxiliary Contact Rating	DC: 24Vdc / 400mA
External Contact Fuse	400mA Fast Acting (Quick Blow)
Dimensions	See page 6
IP Rating	IP67 / IP69K
Cable Length	100 Metres max
Operating temperature	-25°C to +55°C
Storage temperature	-25°C to +55°C
Mounting	Target to target
Construction	Red ABS Resin Filled or 316 Grade Stainless Steel resin Filled

SAFETY CONTROL UNIT (SCU1)			
Supply nominal voltage	24Vac/dc (+/- 15 %)		
Nominal power consumption	3VA		
Safety contacts	2 x NO		
Auxiliary contact	1 x NC		
Output contact rating (max)	4A/230Vac; 2A/24Vdc(Res.)@Cos=1		
Output contact rating (min)	10V/10mA		
Output contact fuse rating	AC=5A; DC=2.5A; Quick blow		
Drop out time	Deactivation by inputs, 13ms		
Internal fuse	100mA Resettable		
Internal fuse recovery time	>2 Seconds		
Internal switches	Reset Manual / Automatic—Selectable		
Max conductor size	1 x 2.5mm stranded with sleeves, 1 x 4mm solid		
Installation group (Control unit)	C in accordance with VDE0110		
IP Rating	Housing IP40, Terminals IP20		
Operating temperature	-10C to +55C (85% Humidity max)		
Storage temperature	-20C to +60C		
Housing material	Polycarbonate Red		
Mounting / Fixing	35mm Symmetric DIN Rail		
Utilisation category in accordance with EN 60947-4-1			
Safety contacts:AC1 at 230 V	Imin:10mA.Imax:4A		
Safety contacts:DC1 at 24 V	Imin:10mA.Imax:2A		
Air gap creepage in accordance with EN 60947-1			
Pollution Degree	2	Weight	210g
Over voltage Category	III	Frequency	10-55Hz
Rated Insulation Voltage	250V	Amplitude	0.35mm
Rated Impulse Withstand Voltage	4.0KV		
Simultaneity Channel 1			
∞			
Simultaneity Channel 2			
∞			

SAFETY RELATED DATA	
PL In accordance with EN ISO 13849-1	PL-e, CAT 4
SIL CL in accordance with EN IEC 62061	SIL 3
PFHd in accordance with EN IEC 62061	3.62 x 10 ⁻⁰⁹
PFH	4.43 x 10 ⁻⁰⁹
B10d	2 X 10 ⁶
MTTFd	>100 years (Based on usage rate of 360 days/year, 24 hours/day, 10 operations/hour)
Tm(mission time)	20 years
DC	96.5%
SFF	98.2%

Mechan Controls Limited - Machine Safety for People and Productivity

Design and manufacture of machine guard safety switches, mechanical interlocks, light curtains and safety relays since 1972.

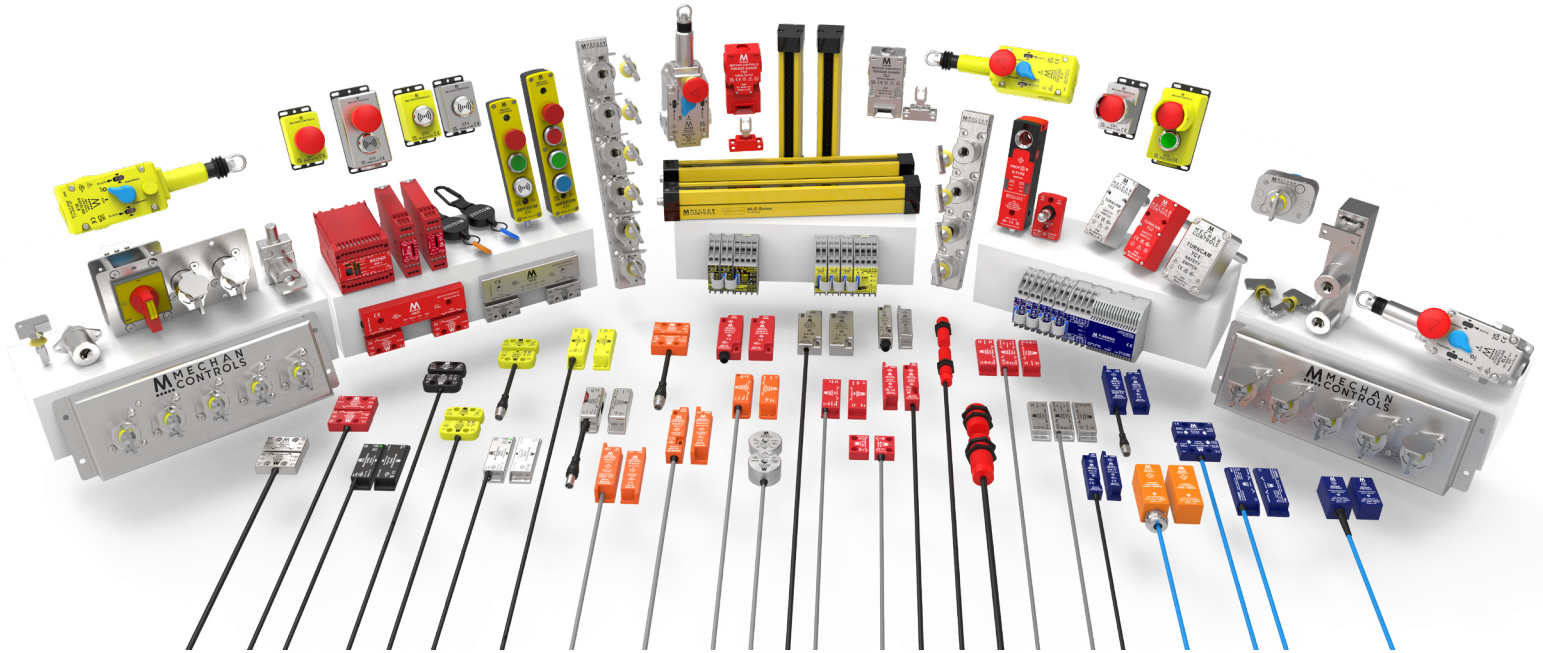

Maintenance

It is recommended to check the safe operation of the of the switches and look for signs of damage or excessive wear on a weekly basis. Damaged units should be replaced or returned to the manufacturer for repair where practical.

Notes

In the interest of product development specifications are subject to change without notice.

It is the responsibility of the user to ensure compliance with any acts or by-laws in place.

All information regarding Mechan equipment is believed to be accurate at the time of printing. Responsibility cannot be accepted for errors or omissions.

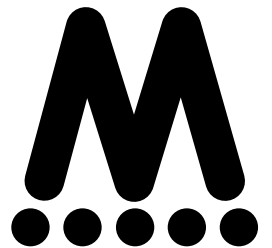

MECHAN CONTROLS LTD
14/16 SEDDON PLACE, STANLEY INDUSTRIAL ESTATE
SKELMERSDALE , LANCASHIRE WN8 8EB
UNITED KINGDOM

Telephone :+44(0)1695 722264
web : www.mechancontrols.co.uk